

7

Characteristics and Dimensions

1 Molded Case Circuit Breakers 140

• NF30-CS	140
• NF32-SV, NF63-CV/SV/HV	142
• NF125-CV/SV/HV	144
• NF125-UV	146
• NF250-CV/SV/HV	148
• NF250-UV	150
• NF125-SGV/LGV/HGV/RGV, NF160-SGV/LGV/HGV, NF250-SGV/LGV/HGV/RGV	152
• NF125-SEV/HEV, NF250-SEV/HEV	154
• NF400-CW/SW	156
• NF400-SEW/HEW/REW	158
• NF400-UEW	160
• NF630-CW/SW	162
• NF630-SEW/HEW/REW	164
• NF800-CEW/SEW/HEW/REW.....	166
• NF800-SDW	168
• NF800-UEW	170
• NF1000-SEW, NF1250-SEW	172
• NF1250-SDW	174
• NF1600-SEW	176
• NF1600-SDW	178

2 Earth Leakage Circuit Breakers 180

• NV32-SV, NV-63CV/SV/HV	180
• NV125-CV/SV/HV	182
• NV250-CV/SV/HV	184
• NV125-SEV/HEV, NV250-SEV/HEV	186
• NV400-CW/SW	188
• NV400-SEW/HEW/REW	190
• NV630-CW/SW	192
• NV630-SEW/HEW	194
• NV800-SEW/HEW	196

3 UL 489 Listed Circuit Breakers 198

• NF50-SVFU, NV50-SVFU	198
• NF100-CVFU, NV100-CVFU	200
• NF125-SVU/HVU, NV125-SVU/HVU	202
• NF225-CWU	204
• NF250-SVU/HVU, NV250-SVU/HVU	206
• NF400-SWU/HWU	208
• NF630-SWU/HWU	210

4 Measuring Display Unit Breakers 212

• NF250-SEV/HEV with MDU	212
• NF400-SEP/HEP with MDU	214
• NF630-SEP/HEP with MDU, NF800-SEP/HEP with MDU ...	216

5 Miniature Circuit Breakers, Residual Current Circuit Breakers, Residual Current Circuit Breakers with Overcurrent Protection and Isolating Switch 218

• BH, BH-P	218
• BH-D6, BH-D10	219
• BH-DN	220
• BV-D.....	221
• BV-DN	222
• KB-D.....	223

6 Circuit Protectors 224

• CP30-BA	224
-----------------	-----

7 Electrical Operated Circuit Breakers 225

BH BH-P

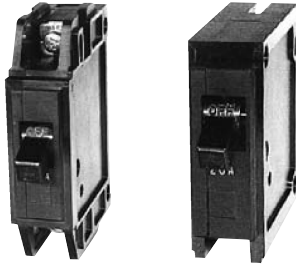

BH

BH-P

Model		BH			BH-P		
Number of poles		1	2	3	1	2	3
Rated current (A) at ambient temperature 40°C		70	70, 100	70, 100	70	70, 100	70, 100
Rated voltage (V)		AC	230/400			230/400	
		DC	125			125	
Rated short circuit capacity (kA)	IEC 60898-1	AC230/400V	3	-	3	-	-
	-	AC400V	-	3	-	3	-
	-	DC125V	1			1	

Operating Characteristics

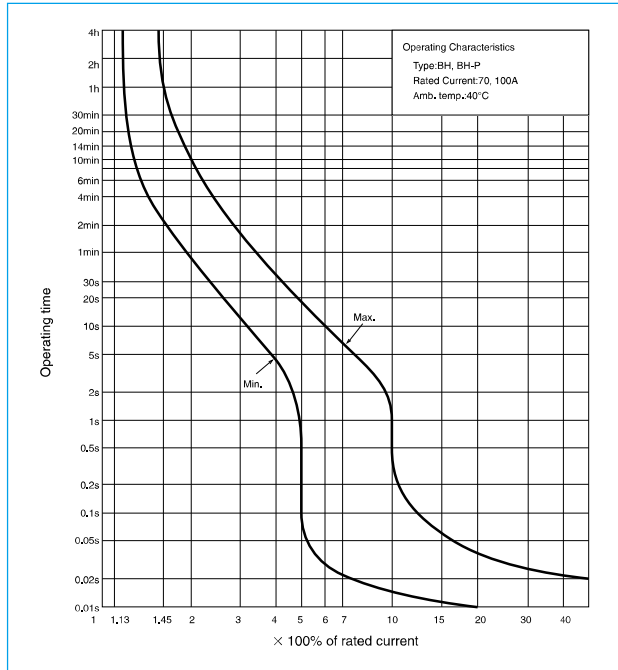

Temperature Compensation Curve

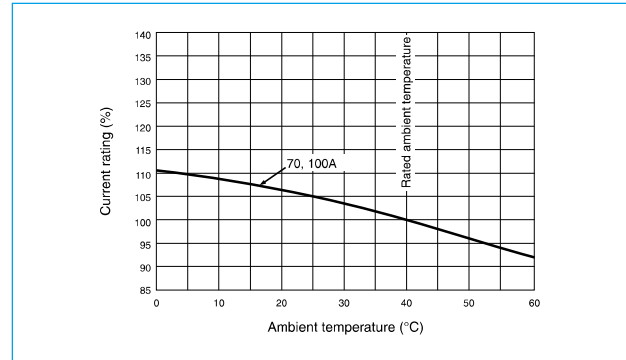

Outline Drawing

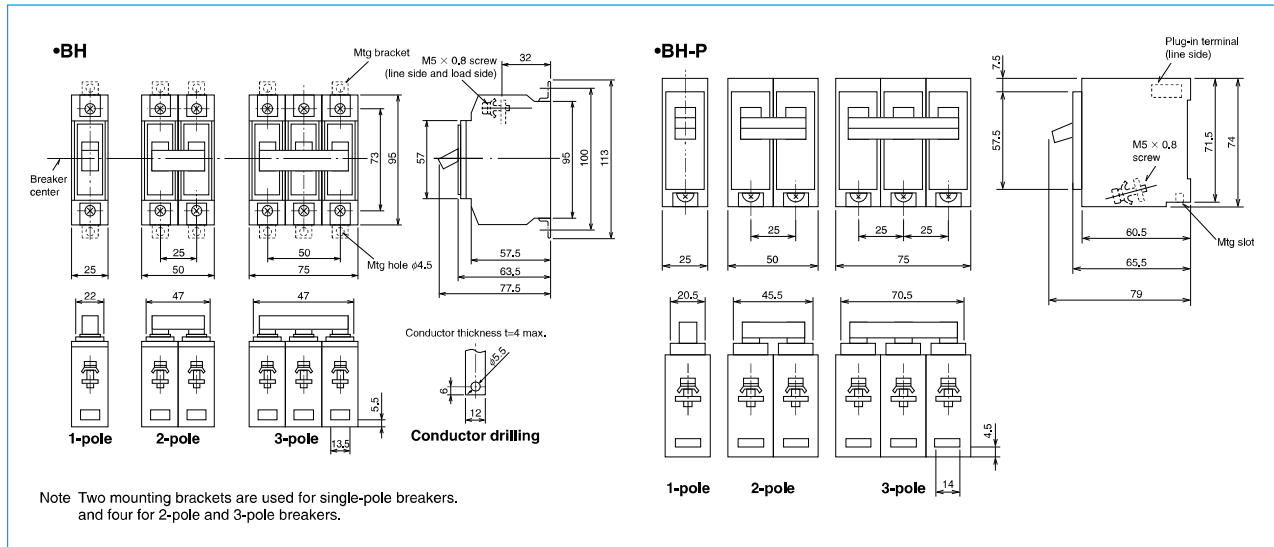

BH-D6 BH-D10



BH-D6

Model		BH-D6					BH-D10				BH-D10 (For DC)		
Number of poles (P)		1	2	3	4(3+N) (*1)	2(1+N) (*1)	1	2	3	4(3+N) (*1)	1	2	
Instantaneous tripping		Type B, C, D					Type B, C		Type B, C, D			Type B, C	
Rated insulation voltage U_i (V)		440					440				250		
Rated current I_n (A) at ambient temperature 30°C		0.5, 1, 1.6, 2, 3, 4, 6, 10, 13, 16, 20, 25, 32, 40, 50, 63					0.5, 1, 1.6, 2, 3, 4, 6, 10, 13, 16, 20, 25, 32, 40		0.5, 1, 1.6, 2, 3, 4, 6, 10, 13, 16, 20, 25, 32, 40, 50, 63			0.5, 1, 1.6, 2, 3, 4, 6, 10, 13, 16, 20, 25, 32, 40, 50, 63	
Rated short-circuit capacity (kA)	IEC60898-1 GB10963.1 (Icn)	AC	230V	6	—	6	10	—	6	—	—	—	
		230/400V	6	—	—	10	—	6	—	—	—		
	400V	—	6	—	—	—	10	—	6	—	—		
	IEC60898-2 GB10963.2 (Icn)	DC	125V	—	—	—	—	—	—	10	—		
			250V	—	—	—	—	—	—	10	—		

Note *1 N pole is a switched neutral pole (without overcurrent release device).

Operating Characteristics

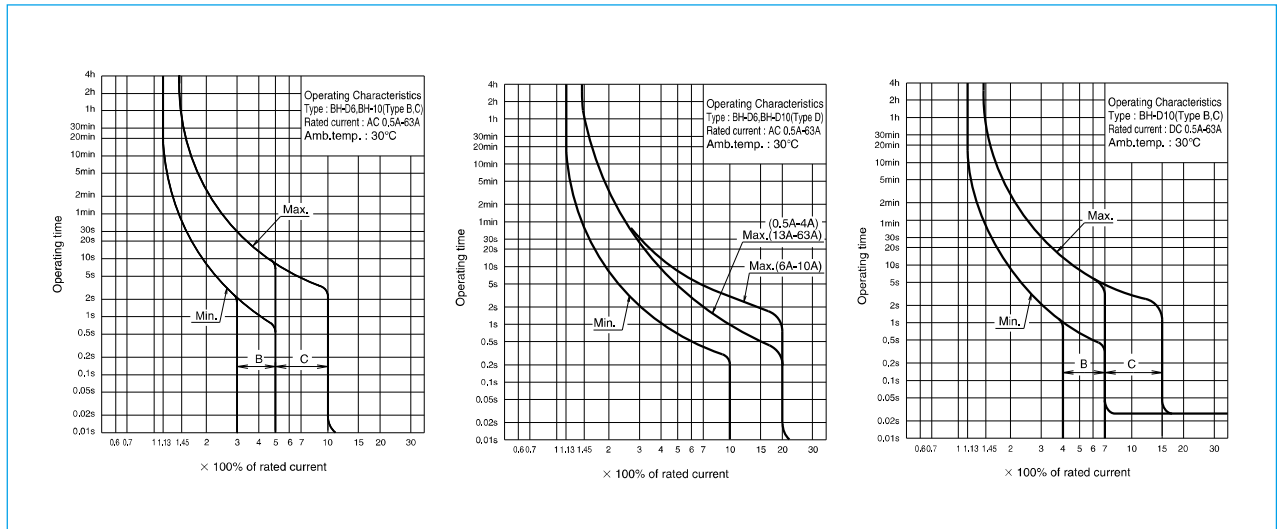

Outline Drawing

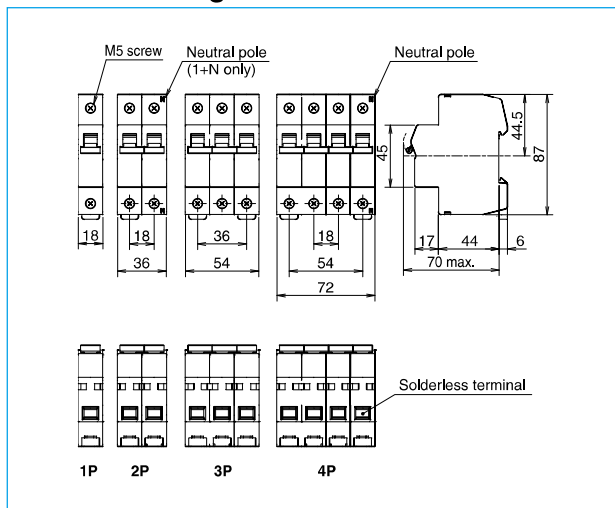

Temperature Compensation Curve

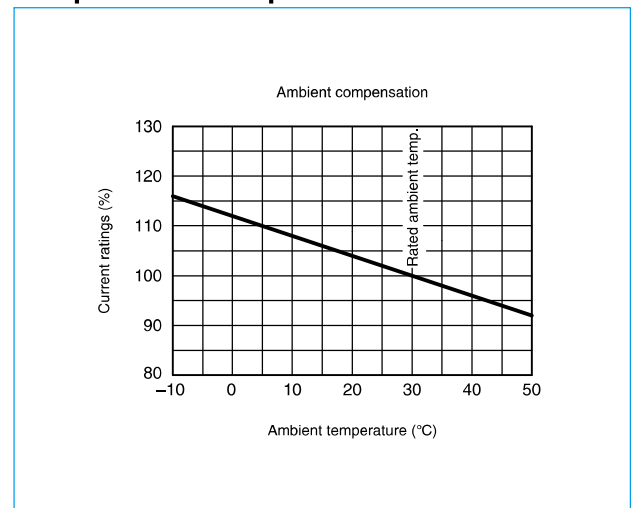

BH-DN



BH-DN

Model				BH-DN
Number of poles (P)				2 (1+N) (*1)
Instantaneous tripping				Type C
Rated insulation voltage U_i (V)				230
Rated current I_n (A) at ambient temperature 30°C				6, 10, 16, 20
Rated short-circuit capacity (I_{cn}) (kA)	IEC60898-1 GB10963.1	AC	230V	4.5

Note *1 N pole is a switched neutral pole (without overcurrent release device).

Operating Characteristics

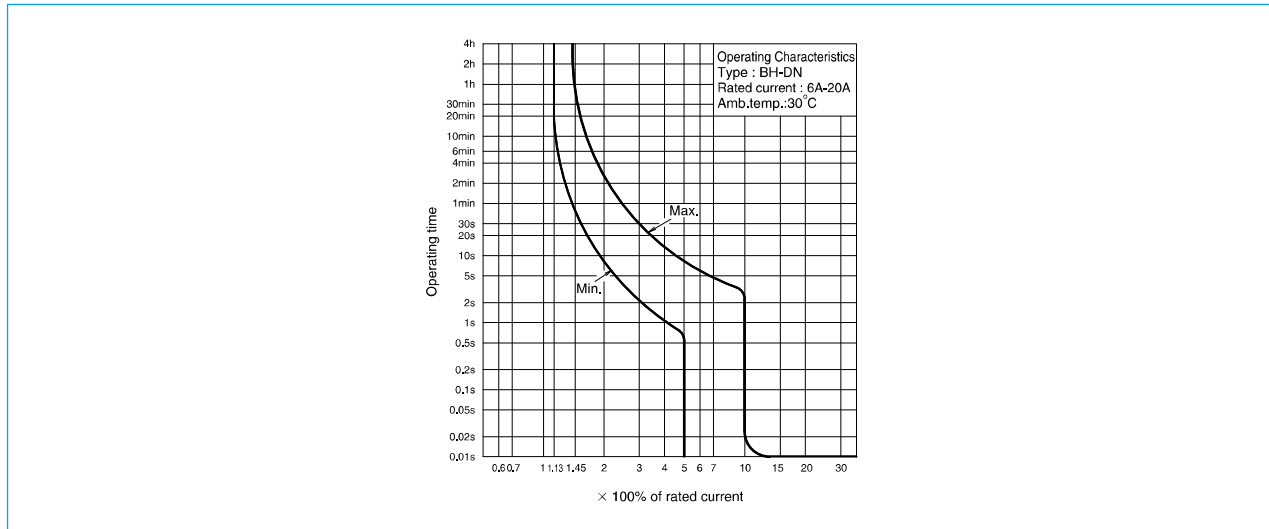

Outline Drawing

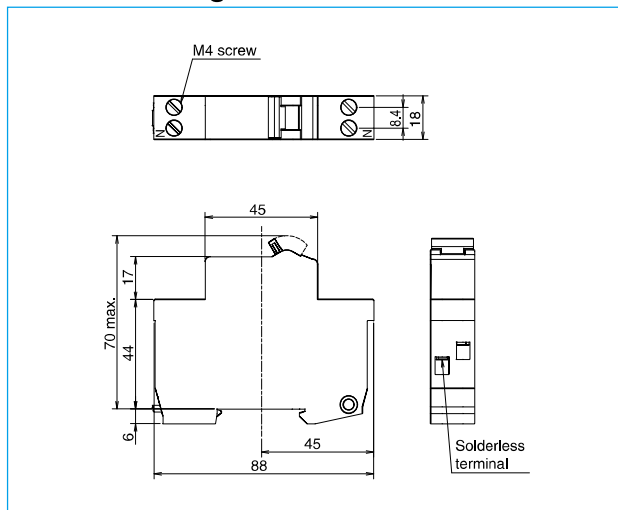

Temperature Compensation Curve

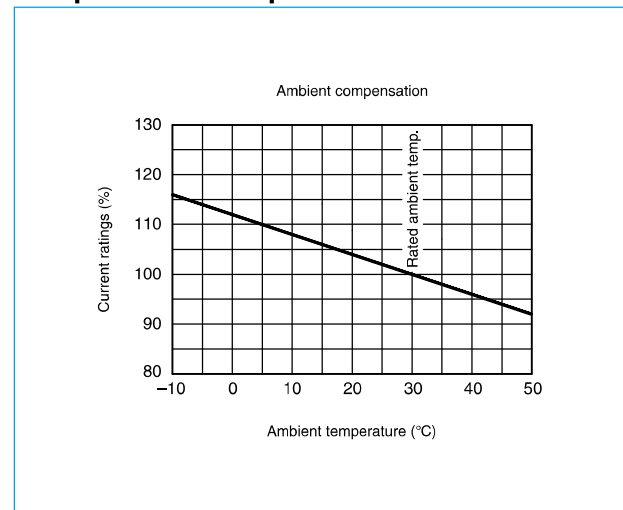

BV-D



BV-D

Model	BV-D	
Number of poles (P)	2 (1+N) (*1)	4 (3+N) (*1) (*2)
Rated operational voltage U _e (VAC)	230	230/400
Rated current I _n (A) at ambient temperature 30°C	25, 40, 63	
Rated current sensitivity I Δ n (mA)	30, 300	
Max. operating time at 5I Δ n (s)	0.04	
Pulsating current sensitivity	Type AC	
Residual operation	Dependent on line voltage	
Rated making and breaking capacity I _m (A)	500 (I _n 25, 40A) 630 (I _n 63A)	
Rated conditional short-circuit current I _{nc} (kA)	6	
Rated residual making and breaking capacity I Δ m (A)	500 (I _n 25, 40A) 630 (I _n 63A)	
Rated conditional residual short-circuit current I Δ c (kA)	6	

Notes *1 N pole is a switched neutral pole (without overcurrent release device).
 *2 For use to three phase 4-wire type. When using, it be sure to connect the neutral wire to the neutral phase. Not available for use to three phase 3-wire type.

Operating Characteristics

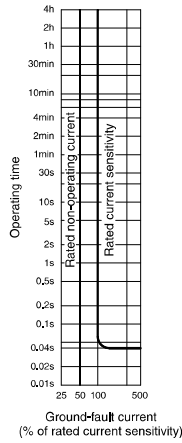

Outline Drawing

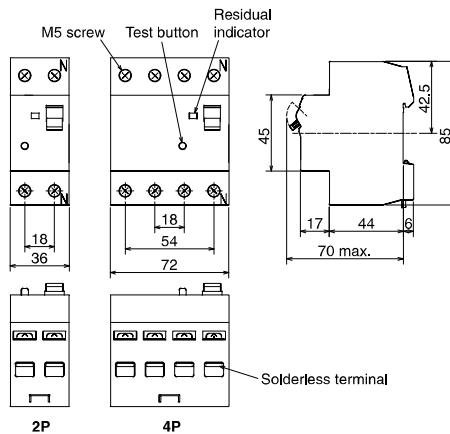

BV-DN



BV-DN

Model		BV-DN		
Number of poles (P)		2 (1+N) (*1)		
Rated operational voltage U _e (VAC)		230		
Rated current I _n (A) at ambient temperature 30°C		6, 10, 16, 20, 25, 32, 40		
Instantaneous tripping		Type C		
Rated current sensitivity I _{Δn} (mA)		30, 100, 300		
Max. operating time at 5I _{Δn} (s)		0.04		
Pulsating current sensitivity		Type AC		
Residual operation		Dependent on line voltage		
Rated short-circuit capacity (kA)	IEC61009-1 GB16917.1 (I _{cn})	AC	230V	4.5

Note *1 N pole is a switched neutral pole (without overcurrent release device).

Operating Characteristics

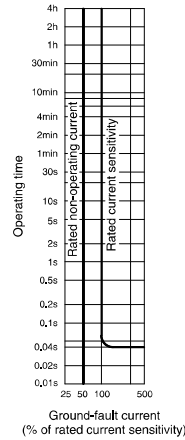
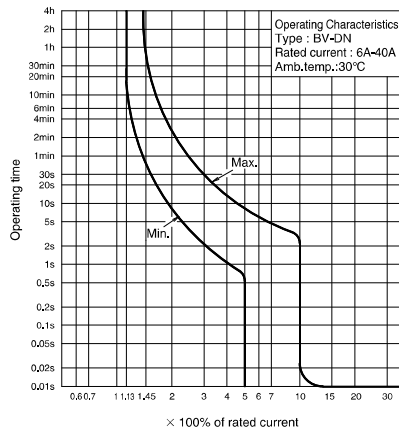

Outline Drawing

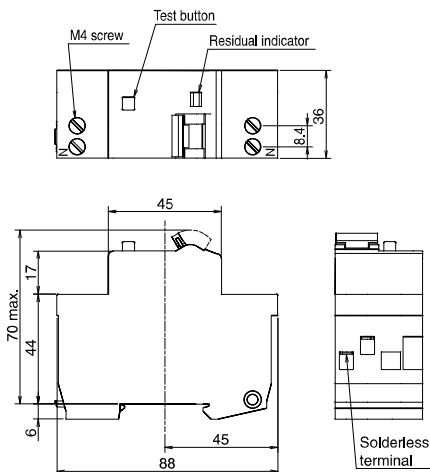

Temperature Compensation Curve

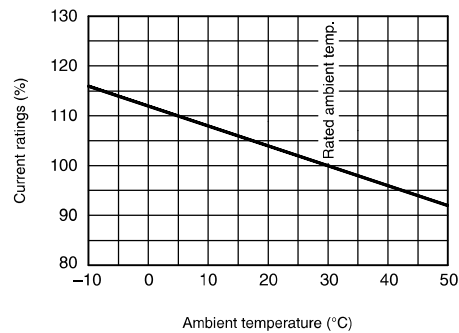

KB-D



KB-D

Model	KB-D			
Number of poles (P)	1	2	3	4 (3+N) (*1)
Utilization category	AC22A class			
Rated insulation voltage U_i (V)	250	440		
Rated voltage U_e (VAC)	230	400		
Rated current I_n (A) at ambient temperature 30°C	32, 63, 80			
Short-time withstand current (A)	20× I_n , 1sec			
Short-time making current (A)	20× I_n			

Note *1 N pole is a switched neutral pole (without overcurrent release device).

Outline Drawing

